



सत्यमेव जयते

Ministry of Rural Development
Government of India

Training rural masons

Learning unit 4



Concrete works



International
Labour
Organization

Table of contents

4.1	Introduction	3
4.2	Reinforcement steel works for concrete structures	4
4.2.1	Type and characteristics of reinforcement steel	4
4.2.2	Reading and interpreting concrete related drawings and sketches	5
4.2.3	Cutting and bending reinforcement steel bars	6
4.2.4	Shaping, placing and fixing reinforcement steel bars	9
4.3	Shuttering works	14
4.3.1	Preparing wooden shutter boards	14
4.3.2	Shuttering works for footings, columns, beams and slabs	16
4.3.3	Scaffolding works	20
4.4	Manual concrete works	22
4.4.1	Preparatory activities for concrete work including manual mixing	22
4.4.2	Pouring, compacting and curing concrete	27

Learning Unit 4

Concrete works



4.1 Introduction

The purpose of this Learning Unit is *to enable a rural mason to describe the construction process for concrete elements as required for rural house construction and carry out the necessary activities including reinforcement bar bending, formwork installation and concrete works.*

By the end of this Learning Unit the rural mason will be able to:

- (i) Install reinforcement steel works for concrete structures in rural house construction
- (ii) Carry out shuttering works for rural house construction.
- (iii) Carry out manual concrete works for rural house construction.

Concrete is a building material used for a number of purposes, including foundations, houses, columns, lintels, beams and slabs. It can be cast in any desired shape and fashion and is therefore applicable for most building purposes. Its long life and relatively low maintenance requirements add to its popularity. Concrete does not rot, rust or decay and is resistant to wind, water, rodents and insects.



Concrete is a mixture of cement, sand and coarse aggregate along with water. Aggregate consists of a mixture of gravel of various sizes. When water is added to this mix, a chemical process takes place primarily with cement, causing the mix to harden.

While concrete performs well under compression, it does not tolerate tension well. To improve the tensile strength, steel bars are added to the concrete in places where tensile stress is expected to occur - such as in beams and slabs.

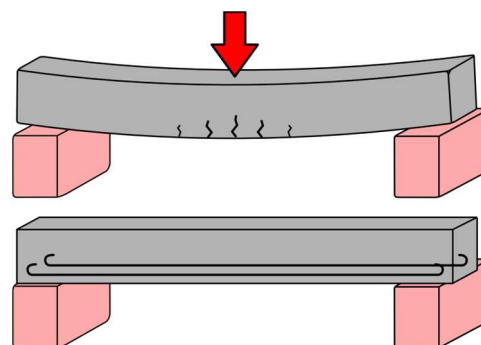

Consequently the load bearing capacity of this composite material called Reinforced Cement Concrete (RCC) is substantially better as compared to when concrete or steel members are used in isolation. With reinforcement steel firmly embedded into the concrete, it can be used to build load-bearing structures such as columns, beams and slabs.

Concrete is cast in moulds referred to as formwork or shuttering. Usually, the formwork used for walls, columns, beams and slabs is assembled by joining wooden boards edge on edge. The advantage of using wood is that it can easily be used to create any required shape. Plywood, laminated boards and metal are also commonly used for formwork.

This Learning Unit provides the necessary information on how to interpret construction drawings with regards to reinforcement arrangements for low cost houses and how to cut, bend and fix reinforcement steel bars to the required shape. It also describes how to prepare shuttering for concrete casting and finally how to prepare, place and compact concrete using manual work methods.

4.2 Reinforcement steel works for concrete structures

This section intends to build the skills of rural masons to:

- Read and explain drawings and sketches describing how reinforcement steel is to be used in concrete structures such as columns, beams and slabs.
- Use hand tools for cutting and bending reinforcement steel bars.

- Fabricate, place and fix reinforcement steel for concrete footings, columns, beams and slabs.

Summary

A drawing for reinforced concrete works describes where and how steel bars are installed. Details are given for the type, size and shape of steel as well as the location and spacing of bars.

Steel bars can be cut and bent on site using simple hand tools, following the instructions given in the bar bending schedule that comes with the drawings. They can subsequently be placed and fixed as per the drawings.

4.2.1 Type and characteristics of reinforcement steel

Reinforcement steel is normally provided as individual steel bars or as steel bars welded together into a mesh. The bars are used for beams and columns, while the mesh is prepared for large surfaces such as slabs and walls.



Reinforcement is also commonly used when building rural houses. The common diameters of steel bars used in building work are 6, 8, 10, 12, 16, 18, 20, 22, 25 and 32 mm.

There are two main categories and purposes of reinforcement steel. The main bars are meant to take most of the tension stresses, while the distribution reinforcement serves the purpose of spreading the load and keeping the main reinforcement in position when pouring concrete.

The main reinforcement bars are placed in the area where tension occurs. It should be adequately covered with concrete with minimum 20 to 25 mm for slabs, 25 to 30 mm for beams on all sides and 40 mm for columns to avoid any corrosion of the reinforcement.

If steel bars need to be extended, some of the critical points to be remembered are:

- The lap length should be greater than 50 times the diameter of the bars used.
- Lapping should not be done close to joints or any other critical areas of the structure.

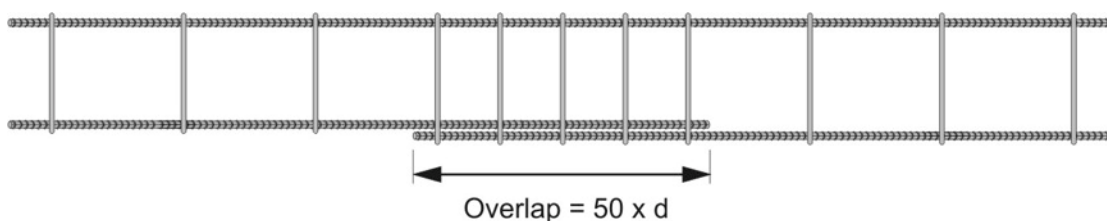

- All the laps should not be concentrated in a single area or straight line as the lap may create a point of vulnerability within the structure.

The surface of the rods should be clean, free from dirt and certainly not covered with shuttering oil or any other release agent to ensure proper bonding with the concrete.

All bars should be completely surrounded by concrete. This ensures that the concrete and steel complement each other and behave as a single composite material, as well as not exposing the steel to moisture in the air that may lead to corrosion.

4.2.2 Reading and interpreting concrete related drawings and sketches

Placing of reinforcement bars for structures requires a working drawing or reinforcement plan, containing all the necessary information. It is important to be able to read this plan in order to cut and bend the required bars to the correct size and shape.

The exact measurement of every re-bar to be used is usually indicated in a bar bending schedule, which is prepared together with the drawings. The bar bending schedule is a chart giving a clear picture of bar lengths and diameters, and where the bars should be placed.

To increase the strength of slabs, reinforcement bars are laid at the bottom of the slab. It is important that the bars do not touch the ground or formwork and that concrete covers the bars on all sides including the bottom. The correct cover is 20 to 25mm for slabs, 25 to 30mm for beams and 40mm for columns. The reinforcement bars are separated from the formwork with spacer blocks. The spacer blocks are placed in such distance from each other that the reinforcement bars do not sag and touch the ground or the formwork. As a rule of thumb, about 4 to 6 cover blocks are required per square metre for slabs.

Spacer blocks can be easily made on site. Prepare a 1:4 mortar mix and set it in a flat tray of about 25 mm depth. Remember to use a plastic sheet or oil so that the blocks can easily be removed from the tray when they set. Follow standard good practices of cement use.

After the mortar begins to set, carve out small squares with 25 mm sides and insert twisted binding wire in each square. Let these pieces set in the tray for about 24 hours. Then, remove the blocks and place them in a bucket of water or place them in a gunny bag that can be dipped in water to cure for at least 14 days. After that period the cover blocks are ready to use.



For some slabs reinforcement bars are required in two layers within the slab. One layer is placed near the bottom and one layer near the top of the slab. Chairs (brackets) are placed to separate the two layers and keep the top layer at the appropriate height. Three to four chairs are needed on average for each square metre of slab.



4.2.3 Cutting and bending reinforcement steel bars

For smaller works in rural areas the reinforcement bars are cut and bent on site. This requires some skill and the appropriate tools. The reinforcement bar bending schedule describes what type of bars to prepare in terms of size, shape and numbers of each type.

The stirrup is the outer frame that holds the load bearing bars in the correct position. These are prepared on site using 10mm diameter bars. The exact length of the bars for stirrups needs to be carefully calculated based on the dimensions of the column or beam. The re-bars have to be covered all round with at least 25mm to 30mm concrete. The stirrups therefore need to be cut and bent to allow for sufficient coverage.

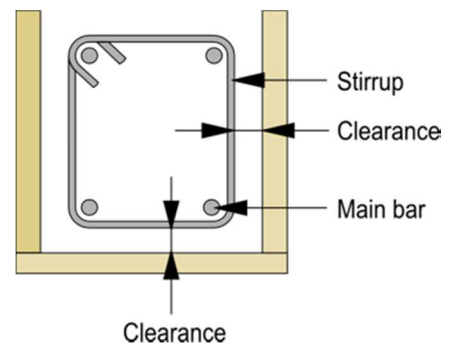

Make sure the end bend is minimum 50mm.

Tips for the facilitation of Worksheet C1: *Cutting and bending reinforcement bars*

When facilitating the work process described in this worksheet the following approach is recommended:

- Display the poster of Worksheet C1 so that all trainees can easily see it.
- Instruct the trainees to open their reference handbook at 'Worksheet C1' and refer to it throughout the lesson.
- Also link your explanation to the respective training posters.
- Start explaining the worksheet by giving a general introduction to the purpose of concrete reinforcement and where it is commonly used in rural housing works. Link your explanation to actual physical work undertaken during this training course (building a house) and also dwell on the experiences of the trainees.

First step:

- Explain and discuss reinforcement plans and bar bending schedules and how to read and interpret them.
- Split the trainees into groups of two or three and give them each a task, e.g. each group is given a different drawing and explains to the other groups how to interpret it. Model re-bars could be cut from wire (to scale) and then given to them to bend according to the schedule.

Second step:

- Explain the basic concept of cutting and bending reinforcement bars including the required safety precautions.
- Demonstrate how it is practically done by referring to the bar bending schedule. Split the trainees into groups of two and give each of them one typical bar to measure, cut and bend → demonstrate → observe → correct → encourage → refer to the worksheet all the time.
- When the trainees have completed their tasks, let them assess each other's work and comment on the achieved quality.
- Recapitulate together the work done. Use the training poster to review the 'Remember List'.

Throughout the training process refer to the required safety at work. Always display Training Poster No. 1: Safety at work.

Worksheet

C1

Activity: Cutting and bending reinforcement bars

Work method:

1. Prepare and clear a level area with adequate space for cutting and bending the required reinforcement bars and stack them neatly.
2. Have the reinforcement bar bending schedule ready and make sure that you are fully conversant with all the bending requirements for your work.
3. Prepare all the necessary tools and bending table required to cut and bend the reinforcement bars.
4. Start with the first bar listed in the bending schedule, measure the correct total length, cut and bend according to the schedule. This first bar is your pilot piece. Before continuing with the remaining bars, check again that the pilot bar conforms exactly to the required shape and size. If it does, continue preparing the remaining bars of this particular shape. After completing one type of bar, stack them neatly and lifted off the ground so as to be easily recognised and kept clean. Keep the reinforcement bars free from mud, oil or any other dirt.
5. Proceed with the same method for each type of bar listed in the bar bending schedule and stack them separately as described above.

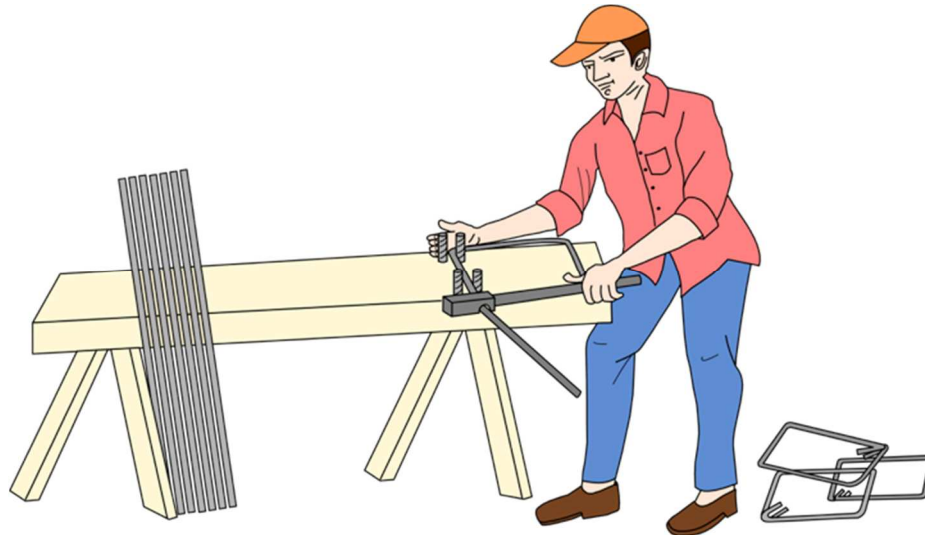

Caution:

Bars should be bent cold and should not be re-bent to avoid weakening the steel.

Labour:

- Rural mason, for cutting and bending
- Labourer to assist

Tools:

- Bending table or stand with bending roles
- Bending lever
- Hack saw with replacement blades
- Pair of pliers
- Hammer
- Tape measure and square

Material:

- Reinforcement bars
- Binding wire

Quality checkpoints:

- Before cutting and bending check whether the quality and quantity of the reinforcement bars correspond with the requirements in the reinforcement plan and bending schedule.
- Confirm correct size and shape with the requirements of the bending schedule.
- Ensure that all prepared bars are neatly stacked and completely clean.

4.2.4 Shaping, placing and fixing reinforcement steel bars

Once the reinforcement steel bars have been cut and bent to the right shape they are ready to be installed in the formworks.

For columns, beams and lintels the reinforcement can be tied together to the correct shape and length before the formwork is installed. They can actually be assembled on the ground ready for installation once the formwork is complete.

The reinforcement plan describes which main bars and stirrups (distribution bars) to use, where they are to be placed and the distance between them.

The main bars are always inside while the stirrups are fixed outside with regular spacing. The stirrups can have different shapes, but should be 'closed' as shown in the drawing. It is important that the stirrups have the correct size to allow for adequate concrete cover (25mm to 30mm for beams and columns in housing).

The stirrups are tied onto the main bars using binding wire.

For slabs the reinforcement bars are usually arranged and tied together when the formwork has been completed. The main bars are at the bottom, while the distribution bars are laid and fixed on top of them.

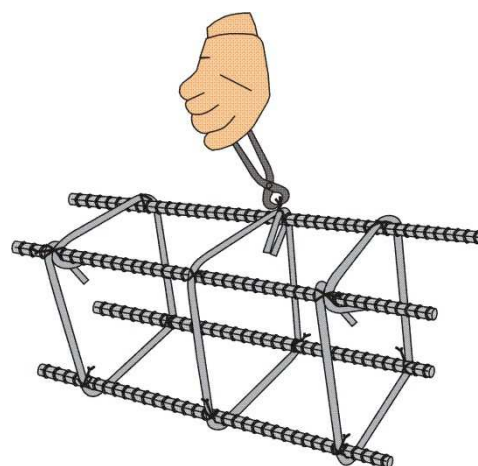
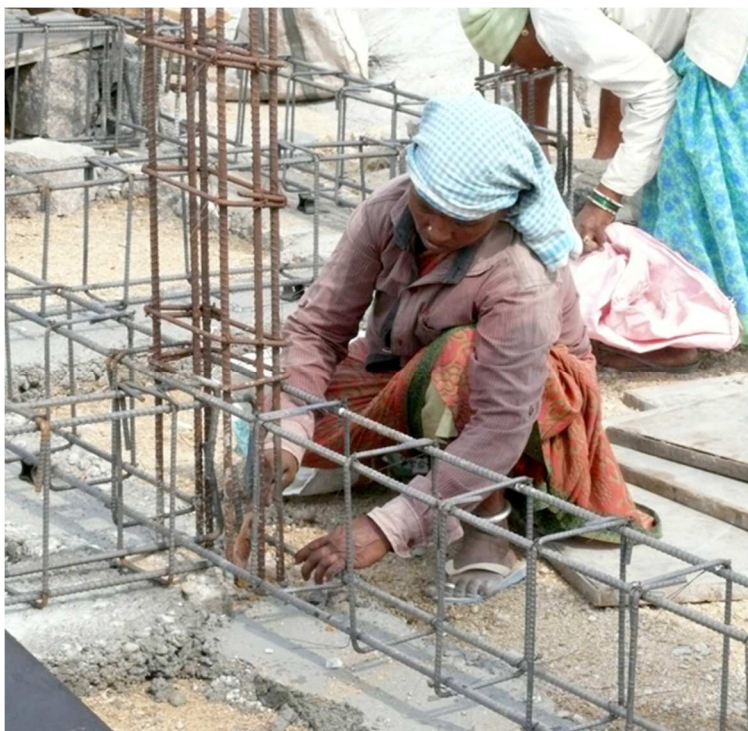

Tips for the facilitation of Worksheet C2: *Fixing reinforcement bars for columns and beams*

When facilitating the work process described in this worksheet the following approach is recommended:

- Display the poster of Worksheet C2 so that all trainees can easily see it.
- Instruct the trainees to open their reference handbook at 'Worksheet C2' and refer to it throughout the lesson.
- Also link your explanation to the respective training posters.
- Start explaining and discussing the worksheet by giving a general introduction to fixing/assembling reinforcement bars for columns and beams. Explain that this can be pre-prepared and only need to be inserted into the formwork when required. Link your explanation to actual physical work undertaken during this training course (building a house) and also dwell on the experiences of the trainees.
- Split the trainees into groups of two. Provide each group with a small 'bar bending schedule' for a column or a lintel that needs to be constructed for the house where the training takes place. Let them cut and bend the bars under your supervision.
- After all the bars including stirrups (if required) are ready, explain and discuss how to assemble the reinforcement bars. Then let them exercise on their own element → demonstrate → observe → correct → encourage → refer to the worksheet all the time.
- When the trainees have finished their job, let them assess each other's work and comment on the achieved quality.
- Recapitulate together the work done. Use the training poster to review the 'Remember List'.

Throughout the training process refer to the required safety at work. Always display Training Poster No. 1: Safety at work.

Worksheet

C2

Activity: Fixing reinforcement bars for columns and beams

Work method:

1. Prepare a stand or a table for assembling the reinforcement bars.
2. Check the exact size and shape of the reinforcement bars with the bending schedule.
3. Start with two main bars by laying them parallel to each other. Slip in and distribute the necessary number of stirrups. Confirm the quantity of stirrups required by checking the distance required between them.
4. Distribute the stirrups along the two main bars with uniform spaces as indicated in the reinforcement plan. Fix the stirrups with binding wire to the two main bars.
5. Slip in the remaining main bars and tie them to the stirrups. Make sure the stirrups are tied to the main bars in a right angle.

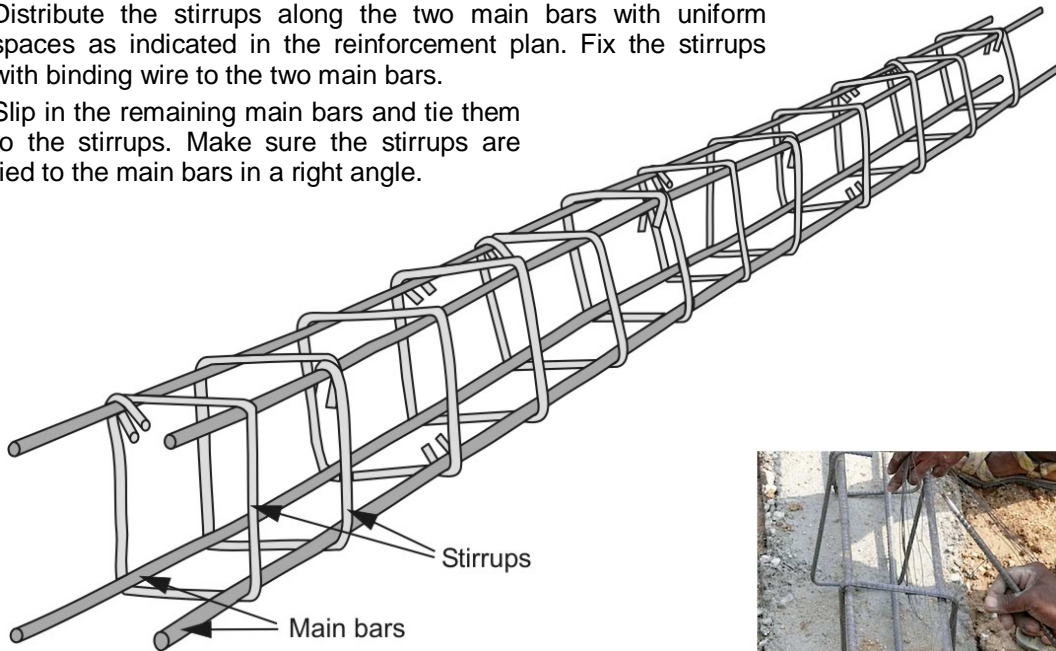

6. The assembled reinforcement can now be placed into the correct position in the formworks, i.e. for a column, beam or lintel.
7. Once the reinforcement has been placed, fix spacer blocks of the required thickness to avoid the bars from touching the formwork, thereby ensuring that the bars will be fully covered by concrete.



Labour:

- Rural mason for fixing
- Labourer to assist

Tools:

- Stands for holding the re-bars when fixing
- Pair of pliers
- Hammer
- Ruler or tape measure and square

Material:

- Reinforcement bars cut and bent to correct lengths
- Binding wire

Quality checkpoints:

- Before fixing check the exact dimensions of the beam, column or lintel and its re-bar arrangement.
- Ensure proper spacing of main bars and stirrups.

Tips for the facilitation of Worksheet C3: *Fixing reinforcement bars for slabs*

Important note: Facilitate this activity only after the slab shuttering has been completed (ref. Worksheet C5)

When facilitating the work process described in this worksheet the following approach is recommended:

- Display the poster of Worksheet C3 so that all trainees can easily see it.
- Instruct the trainees to open their reference handbook at 'Worksheet C3' and refer to it throughout the lesson.
- Also link your explanation to the respective training posters.
- Start explaining and discussing the worksheet by giving a general introduction to fixing/assembling reinforcement bars for slabs. Explain that this can only be done once the formwork is completed. Link your explanation to actual physical work undertaken during this training course (building a house) and also consider the experience of the trainees.
- Split the trainees into groups of two. Provide each group with a small 'bar bending schedule' for preparing a number of the required bars for the slab. Let them cut and bend the bars under your supervision.
- Also let them prepare spacers and chairs with your guidance → demonstrate → observe → correct → encourage → refer to the worksheet all the time.
- After all the bars including spacers and chairs are ready, explain and discuss how to assemble the reinforcement mesh for the slab. Then let them exercise the work until the job is satisfactorily completed, including fixing all spacers and if necessary chairs. Again, demonstrate → observe → correct → encourage → refer to the worksheet all the time.
- When the trainees have finished their tasks, let them assess each other's work and comment on the achieved quality.
- Recapitulate together the work done. Use the training poster to review the 'Remember List'.

Throughout the training process refer to the required safety at work. Always display Training Poster No. 1: Safety at work.

Worksheet

Activity: Fixing reinforcement bars in slabs

C3

Work method:

1. Refer to the reinforcement plan for which bars to use (size, shape and quantity). Also confirm the required spacing between the main bars as well as the distribution bars.
2. Mark with a chalk on the ground or shuttering for the slab the exact position for each main bar. Place the main bars where you have marked. Ensure again that the bars are exactly parallel and with the same distance from each other.
3. Also mark where the distribution bars are to be laid (perpendicular to the main bars and on top of them). The slab reinforcement now looks like a big mesh.
4. Bind all distribution bars to the main bars using binding wire. Make sure all knots are firmly tied.
5. When all the bars have been tied together, the entire mesh needs to be raised and placed on top of spacer blocks.

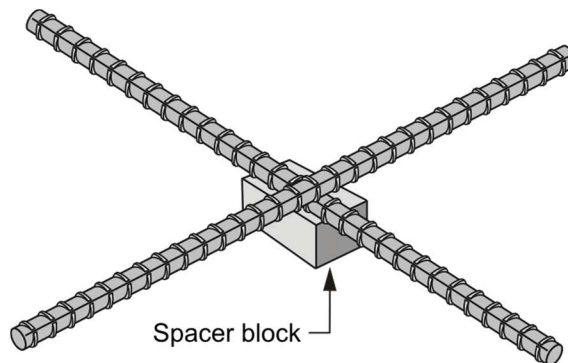

6. For slabs where also an upper reinforcement mesh is required, the same placing and binding arrangements are applied as for the lower one. Instead of spacer blocks, the upper mesh is fixed to chairs in order to lift it to the required height.

Labour:

- Rural mason, for fixing
- Labourer to assist

Tools:

- Ruler or tape measure and square
- Marker or chalk
- Pair of pliers
- Hammer

Material:

- Reinforcement bars
- Binding wire
- Chairs
- Spacer blocks

Quality checkpoints:

- Before fixing check the exact re-bar arrangements as specified in the drawings.
- Ensure proper spacing and tight binding.
- Ensure all necessary chairs and spacer blocks are fixed and properly secured. Make sure no reinforcement bars touch the formwork.

4.3 Shuttering works

This section is intended to enable the rural mason to:

- ✓ Use hand tools for making wooden shutter boards.
- ✓ Carry out shuttering works for reinforcement concrete footings, columns, beams and slabs.
- ✓ Carry out scaffolding works using bamboo/ballies or pipes and couplers for supporting rural housing construction.

Concrete is cast into moulds referred to as formwork or shuttering. Usually, the formwork used for walls, columns, beams and slabs are built by joining wooden boards edge on edge. Formwork can also be made from plywood, laminated boards and metal. The advantage of using wood is that it can easily be cut to any required shape.

Formwork can be re-used several times if well designed, assembled and maintained. Proper positioning and installation of tie props, support and bracings is essential for ensuring a distortion-free form when pouring and compacting concrete.



4.3.1 Preparing wooden shutter boards

Formwork (or shutters) is a temporary mould to hold the fluid concrete until it is hardened and strong enough to carry itself and the reinforced concrete. Formwork needs to be built solid enough to contain the concrete when poured as well as the weight of the reinforcement steel.

Wooden shutters therefore needs to be solid enough to support the weight without any deformations or movements. Shutter boards can be re-used many times if the shape and size of concrete structures are the same, e.g. lintels, beams and columns.

4.3.2 Shuttering works for footings, columns, beams and slabs

Actual shuttering works can commence once the shutter boards have been prepared and ready for use. Besides the boards also tie rods, supports, props and bracings have to be available in good order and sizes as required for the work at hand. What exactly and how much of each is required depends very much on the type of shuttering. Forward planning is essential to ensure that all this material is on site and ready for use, particularly in the case of roof slabs where quite a number of props, stringers and joists are needed.

Using good material for shuttering allows for the elements to be well fabricated and used many times. Therefore it is important to always clean used shuttering material and store it safely and protected from the weather.

The following worksheets explain the shuttering work process for slabs and columns. The same principles also apply for other types of shuttering works.

Tips for the facilitation of the Information Sheet: *Preparing wooden shutter boards*

The Information Sheet on wooden shutter boards is not a worksheet, as it is assumed that shutter boards can be found ready-made in the village.

- However, it is important for the trainees to basically understand how proper shuttering boards should look like and how they ideally should be manufactured.
- It is equally important that the trainees appreciate the need to maintain the boards properly, e.g. cleaning after use, repairs where necessary and safe storing.
- Ask the participants to share their experience and facilitate a discussion how their experience can be utilised for the works they are undertaking.

Throughout the training process refer to the required safety at work. Always display Training Poster No. 1: Safety at work.

Information Sheet

Activity: Preparing wooden shutter boards

Work method:

1. Check the quality of the available timber to be used for the shutter boards, such as plywood and battens. Make sure that the timber is of good quality, straight and clean.
2. Determine the size of the shutter boards, depending on the intended use. For example, for 30cm by 30cm square columns the shutter boards are also 30cm wide while the height depends on the actual column height. If required, cut battens and boards to the appropriate size.
3. First assemble the frames of the shutter boards using battens with proper joints, e.g. dovetail, tendon, mortise and lap.
4. Apply a light film of shuttering oil on the surface, stack all boards neatly and protect them from weather.

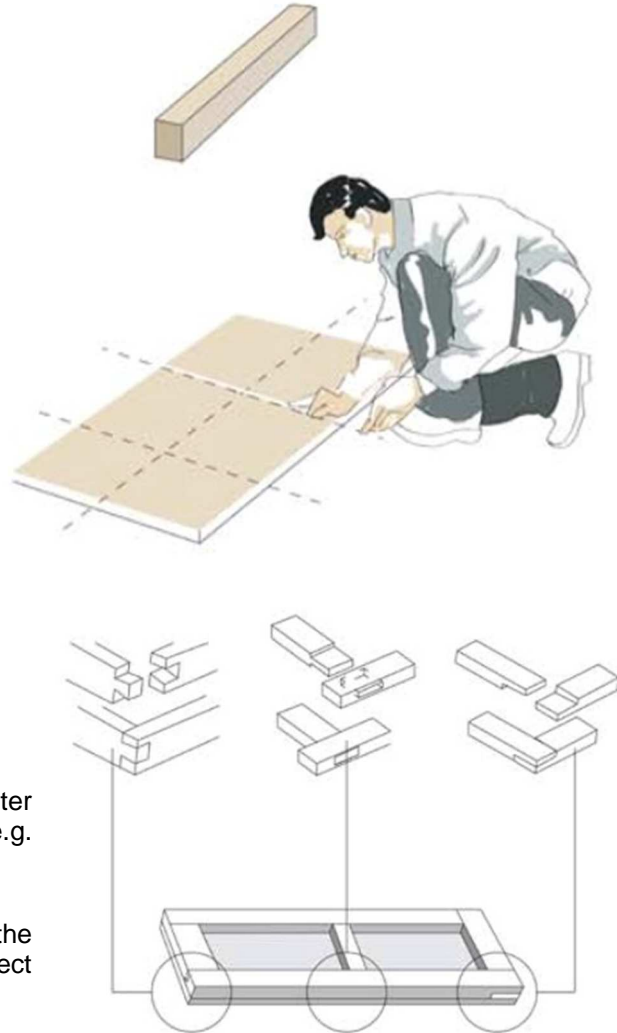

Labour:

- Rural mason, for fixing
- Labourer to assist

Tools:

- Ruler or tape measure and mason's square
- Marker or chalk
- Saw
- Hammer

Material:

- Battens
- Plywood
- Nails, different sizes
- Wood glue
- Shuttering oil

Quality checkpoints:

- Ensure good quality timber.
- Ensure correct size and right angles.

Tips for the facilitation of Worksheet C4: *Shuttering for concrete columns*

When facilitating the work process described in this worksheet the following approach is recommended:

- Display the poster of Worksheet C4 so that all trainees can easily see it.
- Instruct the trainees to open their reference handbook at 'Worksheet C4' and refer to it throughout the lesson.
- Also link the explanation to the respective training posters.
- Start explaining and discussing the worksheet by giving a general introduction to formworks. Explain the concept of formwork with all its parts; shell, bracings, supports and props.

If there are no columns to be constructed on your site, make sure that you still discuss column formwork thoroughly with the trainees. You could do a 'dry-run' using available shutter boards, which you loosely fix together. Also demonstrate the necessary supports, bracings and props that need to be added.

Should there be columns to be constructed, let the trainees erect them. Split the trainees into smaller groups if there are several columns to be constructed. Carefully explain every step and facilitate the process → demonstrate → observe → correct → encourage → refer to the worksheet all the time.

- When the trainees have completed their tasks, let them assess each other's work and comment on the achieved quality.
- Recapitulate together the work done. Use the training poster to review the 'Remember List'.

Throughout the training process refer to the required safety at work. Always display Training Poster No. 1: Safety at work.

Worksheet

C4

Activity: Shuttering for concrete columns

Work method:

1. Confirm the quality and quantity of available shuttering material, i.e. boards, joists, stringers and props. Make sure that the inside of the shuttering boards has been coated with a light film of shuttering oil.
2. Clean the area on which the shuttering will be placed and make sure it is level.
3. Place the assembled reinforcement for the column in the correct position and fix it to the foundation or plinth beam. Make sure the stirrups are correctly spaced and fixed to the main bars and that sufficient spacer blocks are fixed to avoid re-bars touching the shutter boards.
4. Measure and mark the exact position of the column and place shutter boards on two connecting sides. Fix the boards firmly using struts/props and make sure they are vertical and that the two sides are set at a right angle.
5. Before adding a shutter board to the third side, make sure that all the spacer blocks are properly located and no re-bar touches the shuttering.
6. Now close the shutter board on the fourth side. Use a plumb bob to check again that the formwork is vertical and that right angles are maintained in all four corners. Attach struts/props all around and make sure they are firmly anchored in the ground and well fixed to the shuttering to avoid any movement or opening of the shuttering when pouring concrete.

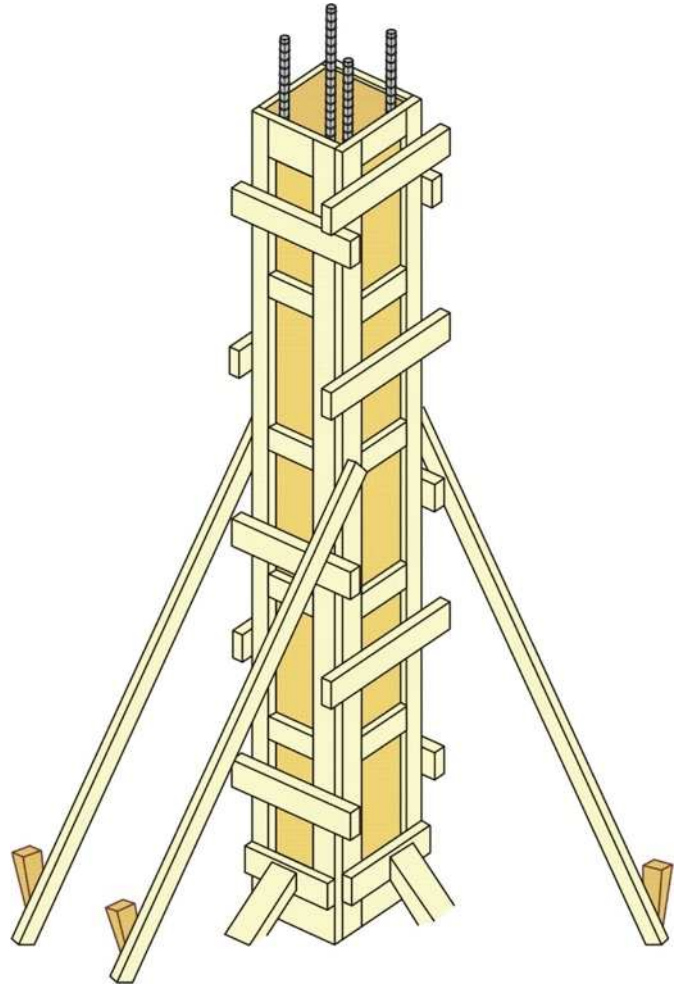

Plug any openings or gaps firmly to avoid any cement paste to seep out.

Labour:

- Rural mason, for fixing
- Labourer to assist

Tools:

- Saw
- Hammer
- Plumb bob
- Spirit level
- Mason's square

Material:

- Shuttering boards
- Struts / props
- Nails, different sizes
- Shuttering oil

Quality checkpoints:

- Check that the formwork is in the correct position, is vertical and reaches the correct level.
- Ensure proper anchoring and support with struts and props.
- Check for any gaps or openings in the formwork.

Tips for the facilitation of Worksheet C5: *Shuttering for short-span slabs*

When facilitating the work process described in this worksheet the following approach is recommended:

- Display the poster of Worksheet C5 so that all trainees can easily see it.
- Instruct the trainees to open their reference handbook at 'Worksheet C5' and refer to it throughout the lesson.
- Also link your explanation to the respective training posters.
- Start explaining and discussing the worksheet by giving a general introduction to slab shuttering. Give particular attention to adequate and secure support arrangements. Ask the participants to share their experiences and what can be learned from them.
- Agree with the participants on what the exact steps are to install the shuttering required for the house you are working on.
- Plan together what resources are required to carry out the shutter works → let the trainees calculate the amount of the various materials required, e.g. number and size of shutter boards, number and size of props/struts, quantity of other support material, etc.
- Make sure a clear distinction is made between preparatory and actual installation works.
- After all material is ready, explain and discuss how to erect the slab shuttering. Then let them exercise the work until the job is satisfactorily completed → demonstrate → observe → correct → encourage → refer to the worksheet all the time.

It is important that you continuously check the levels and the safe erection of props/struts and other support arrangements!

- When the trainees have finished their job, let them assess their work and comment on the achieved quality.
- Recapitulate together the work done. Use the training poster to review the 'Remember List'.

Throughout the training process refer to the required safety at work. Always display Training Poster No. 1: Safety at work.

Work method:

1. Confirm the quality and quantity of the available shuttering material, i.e. boards, joists, stringers, props/support, sills/underlay-boards and bracings.
2. Level the ground on which the shuttering will be erected. Lay underlay boards/pieces on the ground to place the props safely onto them. The first and last boards are placed next to the walls. The boards in-between are laid with a maximum space of 120 to 150cm.
3. Erect the end props on each of the sill boards (ensure equal and correct length) and on top fix temporarily the stringers (usually 10cm x 10cm). Do not insert pieces of stones or bricks at the bottom. Instead use wooden wedges that are nailed to the sill/underlay board once the correct position and height of the prop is confirmed.
4. Lay all the joists (usually 10x10cm) across the stringers with spacing not exceeding 40cm. Fix lightly with a few nails.
5. Now start levelling the whole shutter by lifting or lowering the props until the joists are exactly horizontal in all directions. Use wooden wedges at the bottom of the props to adjust their height.
6. Now lay the shutter boards on top of the joists and make sure they are as close together as possible to secure tight joints. Once this is done you can now fix all the remaining props and add bracing to avoid tilting of the shuttering structure.
7. At the end, clean the surface of the shuttering boards and apply a light film of shuttering oil.

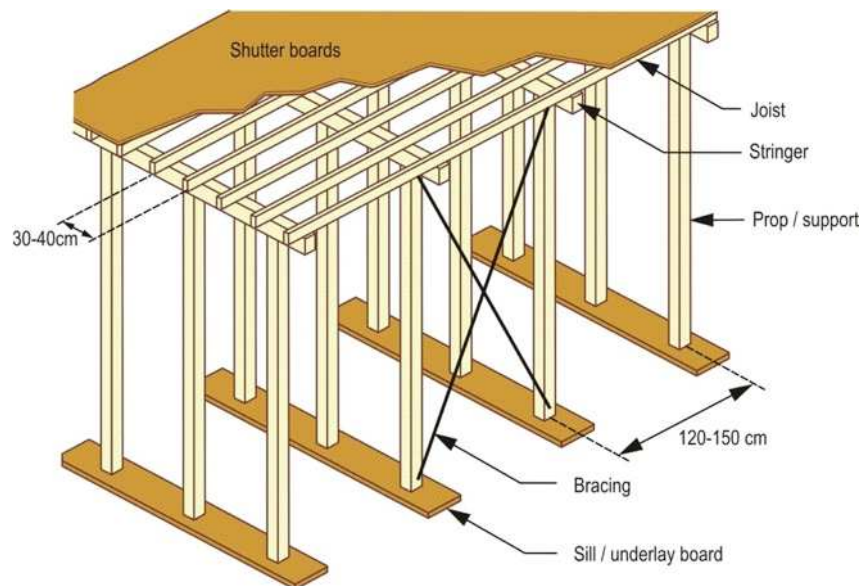

Labour:

- Rural mason, for erecting the formworks
- Labourers to assist

Tools:

- Saw
- Hammer
- Water tube level and spirit level
- Plumb bob

Material:

- Shuttering boards
- Props, stringers, joists and bracers
- Underlay boards
- Nails, different sizes
- Shuttering oil

Quality checkpoints:

- All props needs to be of strong quality and installed in a vertical position.
- The spacing between the stringers should not exceed 150cm and between joists not exceed 40cm.
- Shuttering should be checked before, during and after concrete works to ensure there are no leaks or sags and no compromise on the personal safety of workers.

4.3.3 Scaffolding works

Scaffolding in rural house construction is required for:

- Carrying out masonry works of the upper parts of the walls,
- Installing ventilators,
- Constructing lintels and beams,
- Pouring and compacting concrete for columns,
- Any other work that is required above a height of 1.5 metres from the ground.

Simple but safe scaffolding is required for such works. Usually one level of scaffolding is sufficient. It is important to ensure that necessary safety precautions are made.

- Use appropriate material, such as timber, bamboo or metal pipes with couplers.
- Erect the scaffold on clean and firm ground.
- Add sufficient bracers to avoid any collapse.
- Secure the scaffold firmly to avoid movements and tilting.
- Attach guardrails on all open sides.
- Use walk boards of good quality (no excessive sagging, no cracks, no splinters and wide enough for safe walking).
- Make sure the scaffold and walk boards are solid enough to carry both workers and their building materials.

Tips for the facilitation of Worksheet C6: *Installing scaffolding*

When facilitating the work process described in this worksheet the following approach is recommended:

- Display the poster of Worksheet C6 so that all trainees can easily see it.
- Instruct the trainees to open their reference handbook at 'Worksheet C6' and refer to it throughout the lesson.
- Also link your explanation to the respective Training Posters.
- Start explaining and discussing the worksheet by giving a general introduction to scaffolding as required for house construction works. Link your explanation to actual physical work undertaken during this training course (building a house) and also dwell on the experience of the trainees.
- Ask the trainees to list where scaffolding is required and what qualities are required. Use their experience to develop a common list of important safety requirements.
- Plan together the resources that are required to erect the scaffold for your project. Let the trainees calculate the amount of the materials required, e.g. the number and size of walk boards, number and size of props and struts and quantities of other building materials.
- Make a clear distinction between preparatory and actual installation works.
- After all materials are ready, explain and discuss how to erect the scaffold. Then let them exercise the work until the job is satisfactorily completed → demonstrate → observe → correct → encourage → refer to the worksheet all the time.

It is important that to continuously check the stability of the scaffolding and other safety arrangements.

- When the trainees have completed their tasks, let them assess the work and comment on the achieved quality.
- Recapitulate together the work done. Use the training poster to review the 'Remember List'.

Throughout the training process refer to the required safety at work. Always display Training Poster No. 1: Safety at work.

Worksheet

Activity: Installing scaffolding

C6

Work method:

1. Clear the ground of all debris and ensure that the areas where the props will be placed are firm and even.
2. Erect the props and affix the horizontal struts. Add bracings to avoid tilting. Tie all joints and connections properly and securely. Only use good quality material.
3. Secure the scaffold firmly by anchoring it to the wall and supporting it with struts.
4. Attach guardrails securely to the props.
5. Place walk boards at the appropriate levels and fix securely.



Labour:

- Rural mason
- Labourer to assist

Tools:

- Saw
- Hammer
- Plumb bob

Material:

- Props, struts and bracings
- Guardrails
- Walk boards
- Nails, different sizes
- Wire
- Rope

Quality checkpoints:

- Confirm that the scaffolding is vertical, properly aligned and at the required levels.
- Ensure proper anchoring of struts and props.
- Make sure that all joints and connections are securely tied.

4.4 Manual concrete works

This section attempts to enable the rural mason to:

- ✓ Carry out preparatory work before pouring of manually mixed concrete,
- ✓ Carry out pouring and compaction of concrete, and
- ✓ Finish and cure concrete.

Summary

Manual concrete work is a demanding operation in terms of the various activities and skills required to achieve good quality work. It requires some fundamental knowledge to be able to master the work process as well as to understand the quality requirements.

The quality of material, installation of formwork, preparation and fixing of reinforcement, mixing concrete, pouring and compacting concrete plus finishing and curing are the major activities involved besides other support activities. Concrete works therefore require careful planning and organisation of the work activities.

4.4.1 Preparatory activities for concrete work including manual mixing

Preparations

An efficient work process that eventually leads to good quality concrete can only be achieved if all preparations are carefully considered. These include:

- Checking the formwork and reinforcement,
- Confirming the quality of all materials before mixing,
- Confirming the proportions of the components, i.e. the quantities of aggregate, sand, cement and water
- Making sure that a sufficient amount of all materials is available on site for the job ahead,
- Ensuring that all required tools are available and in good order,
- Organising a sufficient number of labourers available on site for mixing, transporting and pouring the concrete,
- Adhering to the required work safety measures.

Amount of materials

It is important to remember that much more than one cubic metre of components is required to produce a cubic metre of concrete. The reason for this is that the cement and fine aggregate fills the empty spaces between the larger particles. The following table shows the material necessary to produce one cubic metre of concrete.

Concrete mix	Material required to produce 1m ³ concrete		
	Cement (kg)	Sand (m ³)	Aggregate (m ³)
1:2:4	6.5 bags (325kg)	0.45	0.90
1:5:10	2.8 bags (140kg)	0.58	1.15

Mixing

Thorough mixing is essential in order to obtain a homogeneous mixture of all the ingredients and to achieve a suitable workability.

The term workability is used to describe the ease at which the concrete can be placed and consolidated without segregation or separation. The amount of large aggregate as well as the water content greatly influences the workability of concrete, however, these are also factors determining the final strength of the concrete. The large aggregate provides the desired strength in the concrete. Too much water in the mix will reduce the final strength of the concrete.

Manual mixing

Manual mixing is appropriate for smaller quantities of concrete, such as for the level-course in foundations, lintels, columns, etc. For larger quantities it is more practical to use a concrete mixer.

When mixing is carried out by hand it requires a suitable surface (metal sheets, boards or a lean concrete slab) to ensure that the mix is not contaminated with soil. The surface should be level to prevent water from running off the mixing area. The space needs to be sufficiently large to allow for the required size of batches to be mixed without spilling into surrounding areas.

The work process for manual mixing is shown in worksheet C7.

Mechanical mixing

When larger quantities of concrete are required such as when building slabs, it is easier to use a concrete mixer. Mechanical mixing also produces a more homogeneous and better mix.

The following procedure is recommended for loading concrete mixers:

- a) First place a part of the water into the mixer;
- b) Charge half the volume of aggregate. The aggregate will also assist in cleaning the inner surfaces of the drum;
- c) Add the prescribed amount of sand;
- d) Add the cement;
- e) Add the remaining aggregate. The concrete mixer should never be filled completely.
- f) Mix dry for one minute;
- g) When the aggregate and the cement have been thoroughly mixed, add the remaining quantity of water and mix wet for another two minutes.

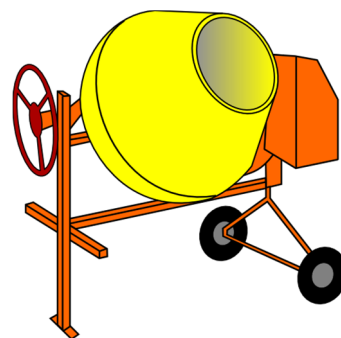

Make sure all tools, platforms and mixers are thoroughly cleaned after the mixing is complete. Leftover hardened concrete may damage the equipment.

Water - cement ratio

The quantity of water divided by the quantity of cement (both measured in kilograms) gives the water - cement ratio.

- A low water to cement ratio leads to high strength but low workability.
- A high water to cement ratio produces a low strength concrete but good workability.

A common shortcoming in concrete works is that too much water is added as it is then easier to spread and compact the concrete.

Caution: Too much water seriously affects the strength of the concrete.

The strength of concrete increases when less water is used during the preparation of the mix. Although the hydration process consumes a certain amount of water, wet concrete actually contains more water than required for the hydration reactions. The excess water is added to provide the wet mix with sufficient workability. Concrete needs to be workable so that it can be moulded into the desired shapes and consolidated to the required density.

A careful balance of cement to water is therefore required when preparing the mix. Water-cement ratios in the range between 0.4 and 0.6 provide a good workability without compromising the strength of the concrete. Hand-mixed and hand-placed concrete requires more water to achieve sufficient workability (water/cement ratio between 0.5 and 0.65).

Example:

For one 50 kg bag of cement.

- The quantity of water with a ratio of 0.4 means that you add 20 litres of water per bag of cement ($0.4 \times 50\text{kg} = 20 \text{ litres/kg of water}$)
- The volume of water with a ratio of 0.5 means 25 litres of water per bag of cement ($0.5 \times 50\text{kg} = 25 \text{ litres/kg of water}$)

Rule of the thumb for hand mixing: between 20 litres and maximum 25 litres of water per bag of cement.

The *Laddu test* is a common hands-on procedure to find out whether the water-cement ratio is correct. Form a ball of ready mixed concrete in your hand, knead it well, throw it up about 60cm and catch it again. If the mixture retains the form of a ball, then the water-cement ratio is acceptable. The water-cement ratio is not correct if the ball disintegrates when you catch it.

When pouring concrete for columns you may need slightly more water in order to ensure that concrete reaches all corners in the tight space inside the formwork, to avoid honeycombs.

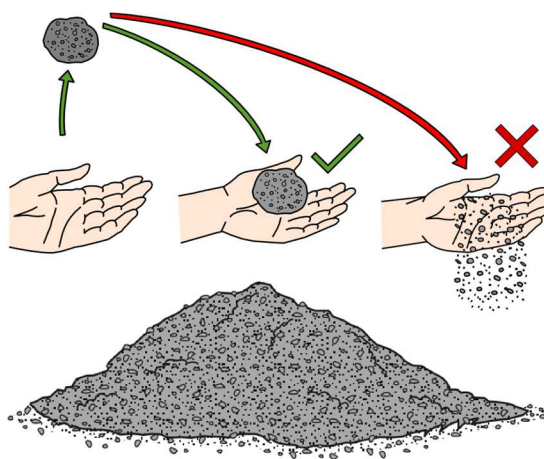

Caution:

When adding water also consider the existing moisture content of sand and aggregate. After rains it might not be necessary to add the full amount of water as mentioned above.

Additional water should never be added when a mix is drying up. If it is necessary to improve the workability of the concrete, a mixture of cement and water should be used instead.

Safety

When handling cement or fresh concrete, it should not come in contact with the skin or eyes. Wearing gloves, a long-sleeved shirt, full-length trousers and boots reduces the exposure. Wet concrete, mortar or cement should be washed from the skin immediately. Eyes need to be flushed with lots of water for at least 20 minutes immediately after contact.

A facemask may be required when mixing concrete as the mixing process often creates a lot of dust.

Tips for the facilitation of Worksheet C7: *Mixing concrete*

When facilitating the work process described in this worksheet the following approach is recommended:

- Display the poster of Worksheet C7 so that all trainees can easily see it.
- Instruct the trainees to open their handbook at 'Worksheet C7' and refer to it throughout the lesson.
- Also link your explanation to the respective training posters.
- Start explaining the worksheet by giving a general introduction to the purpose of the described work. Link your explanation to actual physical work undertaken during this training course (building a house).
- Explain the principles of mixing concrete as per the worksheet. Give particular attention to the correct proportion of cement, sand and aggregate plus the amount of water that should be added for good quality concrete.
- Split the class into work groups of three trainees. Each group mixes first dry sand and aggregate with cement until the mix is uniform. Then mixing continues by adding the correct amount of water.
- Give particular attention to the water-cement ratio. Introduce the concept of the Laddu Test as a simple test that can be done on site.
- Ensure that all trainees practice every work step → demonstrate → observe → correct → encourage → refer to the worksheet all the time.
- When the trainees have completed their tasks, let them assess each other's work and comment on the achieved quality.
- Recapitulate together the work done. Use the training poster to review the 'Remember List'.

Throughout the training process refer to the required safety at work. Always display Training Poster No. 1: Safety at work.

Worksheet

C7

Activity: Manual mixing of concrete

for structures such as lintels, beams, columns and slabs 1:2:4
for lean concrete for foundations and base course for floors 1:5:10

Work method:

1. Before mixing and pouring concrete, check that the formwork is complete and that the reinforcement has been properly assembled.

2. Check the quality of materials prior to mixing concrete: potable water, cement grade and manufacturing date, quality of sand and aggregate, and its purity.



3. Concrete for structures (1:2:4):

A. Place and spread four parts of aggregate and two parts of sand on a clean platform or other hard surface.

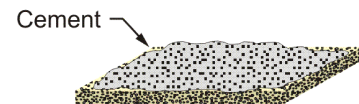

B. Add one part of cement on top of the sand.



C. Thoroughly mix aggregate, sand and cement until a uniform grey mixture is achieved. The general rule is that sand, aggregate and cement are mixed together dry at least three times before adding water. This is important for achieving a uniform mix.



D. Dig a hole in the centre of the heap and carefully add water.

E. Continue mixing until the concrete has the desired consistency. The optimal water content is when the mix allows you to mould a ball in your hand.



4. When mixing lean concrete (1:5:10) use the same procedure as above but with the proportion of one part cement, five parts sand and ten parts aggregate.



Rule of thumb for the amount of water to be added: 25 to max. 30 litres of water for each bag of cement. With a good mix, you should be able to form a ball in your hand.

Labour:

- Rural mason
- Labourers to assist

Tools:

- Clean platform for mixing
- Shovels and spades
- batching box or measured buckets
- Water buckets
- Gunny bags to cover fresh concrete

Material:

- Clean and sieved sand
- Correctly graded aggregate
- Cement (no lumps, not expired)
- Clean water (no salt water)

Quality checkpoints:

- ✓ Check that the cement has not passed its expiry date and contains no lumps.
- ✓ Ensure that the sand and aggregate is clean and with the correct grain size.
- ✓ Continuously check that batching is done to correct proportions and numbers of batches.
- ✓ Continuously check consistency when mixing and control the use of water.

4.4.2 Pouring, compacting and curing concrete

Once the concrete has been mixed it needs to be placed and compacted. These two activities are carried out simultaneously. Placing and compaction of concrete should be done without causing any segregation of its ingredients. When placing the concrete, care need to be taken not to damage the formwork or dislodge the reinforcement. The following process takes place:

- Placing the concrete starts from the corners of the formwork with compaction of the concrete starting immediately after it has been placed. The concrete should be placed in layers not higher than 30 cm when compacted by hand and in layers not higher than 60 cm when compacted by vibration.
- Slabs and floors should be poured in one continuous operation to avoid any vertical or horizontal joints, which can create planes of weaknesses within the structure.

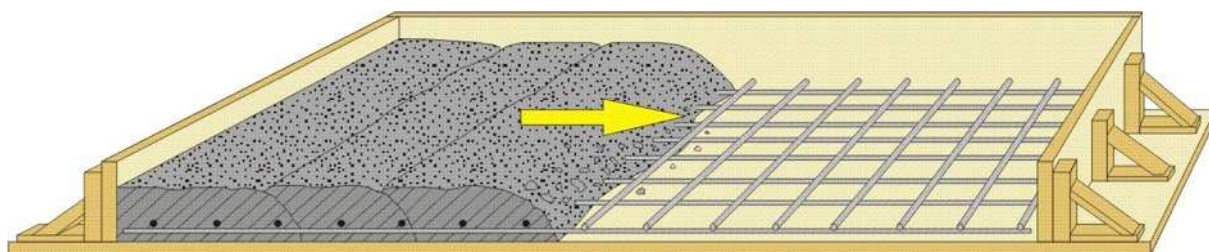

- If the concrete is not properly compacted, air will remain inside the pour. When it hardens, the concrete then appears with honeycomb spots or rashes. As these spots contain a considerable amount of air, they compromise the strength and impermeability of the concrete.
- Consolidation/compaction can be done by hand with hand-tampers or iron rods.
- A more effective method is to use a poker vibrator. The vibrator is immersed into the concrete at regular intervals of half a metre apart. Vibration should not be longer than 10 seconds in one place and the vibrator should be kept away from the formwork and reinforcement bars. Excessive vibration causes the aggregate to segregate.
- If concrete is not properly poured and compacted, honeycombing and voids will be formed which weakens the structure.
- After the concrete has been properly compacted, the top of the concrete is levelled to a smooth surface with a mason's trowel or a float. For large surfaces, a straight edge is used as a screed for levelling the concrete. The straight edge is worked back and forth in a sawing fashion to level the entire surface of the concrete.
- Make sure that the correct volume of concrete is poured to the levels marked inside the formworks. Keep an eye on the reinforcement and ensure that the concrete adequately covers the reinforcement bars.



Proper curing essentially consists of keeping the concrete moist during the period during which it is gaining strength. This is secured either by containing the water already added to the concrete when it was poured or by replenishing its surfaces with additional water to compensate for any water lost through evaporation. The most common method of keeping concrete moist is by frequently sprinkling or flooding the surface, or by covering the surface with wet gunny bags.

Covering the surfaces with plastic sheets, banana or palm leaves or other materials also reduces the evaporation from bright sun and wind. Delaying the removal of the formworks as long as possible also reduces moisture loss.

Gains in strength of well-cured concrete take place as follows:

Curing duration	Strength gain
3 days	40%
7 days	65%
28 days	100%

The shuttering should be carefully removed and only after the necessary strength has been achieved. The following table shows the schedule for removing shuttering for different structures in a rural house:

Concrete structure	Duration before removal of shuttering
Columns, side of beams and slabs	after 2 days
Slab less than 4.5m span	after 14 days
Slab more than 4.5m span	after 21 days
Lintel with sunshade	after 14 days
Below beams less than 6m span	after 14 days
Below beams more than 6m span	after 21days

Tips for the facilitation of Worksheet C8: *Pouring, compacting and curing concrete*

When facilitating the work process described in this worksheet the following approach is recommended:

- Display the poster of Worksheet C8 so that all trainees can easily see it.
- Instruct the trainees to open their handbook at 'Worksheet C8' and refer to it throughout the lesson.
- Also link your explanation to the respective training posters.
- Start explaining and discussing the worksheet by giving a general introduction to working with concrete. Link the explanation to the actual physical works undertaken during this training course (building a house) and also consider the experience of the trainees.
- Plan together the resources that are required to build a concrete slab. Let the trainees calculate the amount of materials required:
 - the total volume of concrete required for the job plus the amount of cement, sand and aggregate to achieve the total required volume (ref. Worksheet C7)
 - the scaffolding required for this job (ref. Worksheet C6)
 - the tools required for the job (ref. Worksheet C8)
 - the number of workers required to assist in the mixing and pouring process
- After all material and arrangements are ready, explain how to arrange and carry out the concrete works. Include their experience and make a plan how to organise the work:
 - How many labourers are required to mix the concrete ensuring a continuous supply?
 - How many labourers are required to transport the concrete from the mixing place to the slab?
 - How many workers (labourers and masons) are required to compact, screed and finish the concrete?
- After all the arrangements are satisfactorily carried out let the trainees do the job under close guidance and supervision → demonstrate → observe → correct → encourage → refer to the worksheets all the time.
It is important to continuously check the proper mix of concrete.
It is important to continuously check the compaction process.
- When the trainees have completed their tasks, let them assess each other's work and comment on the achieved quality.
- Recapitulate together the work done. Use the Training Poster to review the 'Remember List'.

Throughout the training process refer to the required safety at work. Always display Training Poster No. 1: Safety at work.

Worksheet

C8

Activity: Pouring, compacting and curing concrete

Work method:

1. Check the formwork for any dirt, gaps (leakage) and misalignment. Also check for unsecured or insufficient props, bracings and other support arrangements.
2. Make sure the concrete has the correct proportions and water content – *with a consistency like curd-rice*.
3. Wet the shuttering with clean water just before pouring concrete.
4. Pour concrete in layers that can be easily compacted: by hand, not more than 30cm and by vibrator, not more than 60cm.
5. Pour and compact the concrete without any break until the entire job is completed.
6. Use an iron rod to compact columns. Also knock the shuttering lightly from the outside with a wooden hammer. As soon as the cement slurry seeps through the shuttering gaps, then compaction has been achieved (provided the water content is correct).
7. When hand compacting slabs, first use iron rods and then finish off with wooden dampers.
8. When compacting using a vibrator never keep the vibrator on the same spot for more than 10 seconds. Avoid touching the reinforcement bars or formwork.
9. When pouring slabs, start at on one end of the shuttering. Immediately compact and screed the surface using rakes and long straight edges. Fill any depressions and screed again.
10. Use a large size float to finish and smoothen the surface.
11. Immediately cover the surface with a PVC sheet or wet gunny bags.
12. Cure the concrete continuously for 14 days. Do not remove the shuttering before 14 days for spans below 4.5m and 21 days for spans more than 4.5m

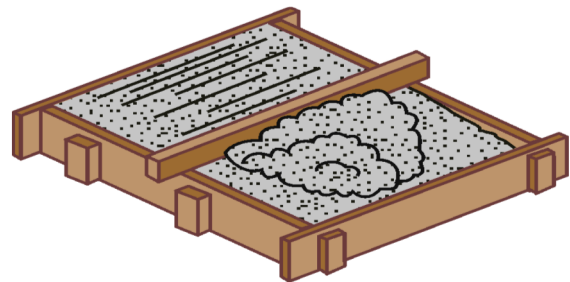
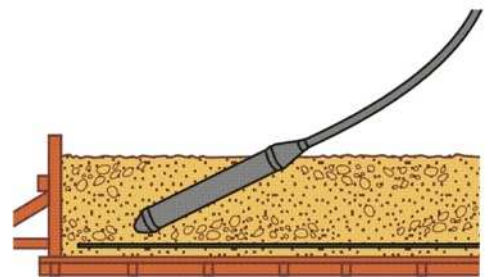
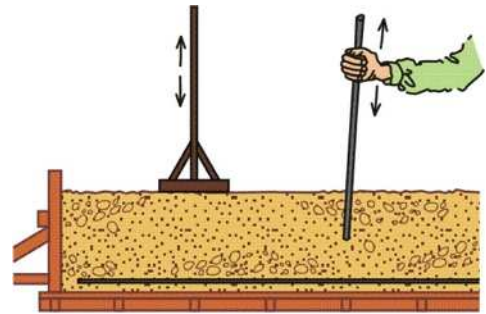

Labour:

- Rural mason
- Labourers to assist

Tools:

- Complete masonry tool set
- Shovels and rakes
- Buckets to carry concrete and water
- Iron rods, wooden dampers and wooden hammer
- Vibrator for mechanical compaction
- Straight edge
- Gunny bags to cover completed concrete area

Material:

- Ready mixed concrete (see Worksheet C7)
- Water

Quality checkpoints:

- Check the quality, alignment, support and cleanliness of the formwork and reinforcement before pouring concrete.
- Ensure properly installed scaffolding and necessary safety precautions.
- Continuously check the consistency of the concrete.
- Control the height of layers and ensure proper compaction.
- Ensure proper finishing and that continuous curing measures are taken.

